

*COLLINS RADIO
GOLD DUST TWINS*

KWS-1 TRANSMITTER

75A-4 RECEIVER



ADG

CQ

RADIO AMATEURS' JOURNAL

APRIL
1955
35c

WOW!

a 1000-watt rig!



1000-WATT
AMPLIFIER

TUNING
CORES

VFO

SSB
GENERATOR

in this issue =

Automatic Code
Collins KWS-1
CW Monitor

WHY ARE THEY CALLED THE GOLD DUST TWINS?

KWS-1 SOLD FOR	\$1435
75A-4 SOLD FOR	\$695
IN 2015 DOLLARS,	\$18,903.91
AVERAGE EARNING IN 1955?	

\$3301.44

75A-4 RECEIVER

RESTORED BY HOWARD MILLS, W3HM IN 2000



75A-4 RECEIVER



75A-4 FILTERS



KWS-1 TRANSMITTER



KWS-1 TRANSMITTER

A TRUE BOAT ANCHOR !



Date: Sat, 10 Jan 1996 17:33:12 -0800
Reply-To: crippel@exis.net
Sender: Collins Collectors List <COLLINS@LISTSERV.TEMPE.GOV>
Comments: Authenticated sender is <crippel@exis.net>
From: Chuck Rippel <crippel@EXIS.NET>
Subject: FWS-1 "Deadly Caps" List
Content-type: text/plain; charset=US-ASCII

Someone asked me to post the list of "caps that must go" in a KWS-1.
Here is the list I compiled after doing mine.

KWS-1 Capacitor Replacement List
1/31/96

Here is the Cap list:

C-325 .0033uf 8400V
C-324 .47uf 9100V
C-403 .1uf 8200V
C-413 .1uf 8150V

C-113 .01uf 8400V
C-115 .01uf 8400V
C-122 .001uf 8400V
C-127 .1uf 8150V
C-134 .1uf 8150V
C-303 .033uuf 8400V

Power supply:
C-506 .022uf 8400V

There are also the blue capacitors in the audio section.

C-116 .5uf 8200V
C-114 .2uf 8200V
C-106 .5uf 8400V

Jack, W8BBFS said that his ALC meter drift problems were cleared up
after replacement.

Chuck Rippel - WA4RNG
Board Member and Secretary to the Collins Collectors Association
Redistribution of postings to this list are by permission only
CCA Member Number: 4
AMI Number: 950
Society of Broadcast Engineers #21735
Reply to: crippel@usa.net

To subscribe: listserv@listserv.tempe.gov
and in body: subscribe COLLINS yourfirstname yourlastname
To unsubscribe: listserv@listserv.tempe.gov
and in body: signoff COLLINS
Archives for COLLINS: <http://www.tempe.gov/archives>



Bringing Up a Collins KWS-1

Tony Brock-Fisher, K1KP

The following procedure may serve as a useful guideline to bringing up a long-dormant KWS-1 for the first time. It is a guideline only; the author assumes no liability for damage to equipment or personal injury resulting from the use of this procedure.

REMEMBER SAFETY FIRST!

- One hand in your pocket!
- Don't defeat interlocks!

First, check out the power supply alone without the RF deck connected. This will allow you to check the LV supply, bias supply, and filament outputs. Depending on availability of a Variac, you may want to initially bring up power slowly over time to allow the electrolytic caps to 'reform'.

Before applying any voltages to the power supply, it might be a good idea to 'ohm out' the supplies. Using a VTVM, or a DVM on a 100K scale, measure the resistance to ground of the LV and bias supplies. They should charge up to several 10's of Kohms as the caps charge. Any low readings indicate shorts and should be investigated before applying power.

First, if the unit is new to you, you may want to double check the primary wiring. The power supply can be wired for either 115 or 230V. It would certainly ruin your day to plug it into 230 when it's set up for 115V!

With the Power Supply disconnected from the RF deck, the Filament switch will apply power to the LV supply, PA bias supply, blower, HV rectifier filaments, and PA filaments. The green light should come on over the switch.

When you get the unit up to 115V, you can check the appropriate voltages on TB502 and TB501. Note that the LV may be very high without a load on it – don't run the supply too long this way or you may zorch the electrolytics from excessive voltage.

Check that you can control the PA bias voltage with the front panel pot.

You can't check out the HV supply or PA screen supply without the RF deck, as those voltages are enabled by a 110V contactor controlled by the Emission



Collins

KWS-1
AMATEUR
TRANSMITTER



INSTRUCTION BOOK



KWS-1 TRANSMITTER

COMPONENT LAYOUT



KWS-1 TRANSMITTER

COMPONENT LAYOUT

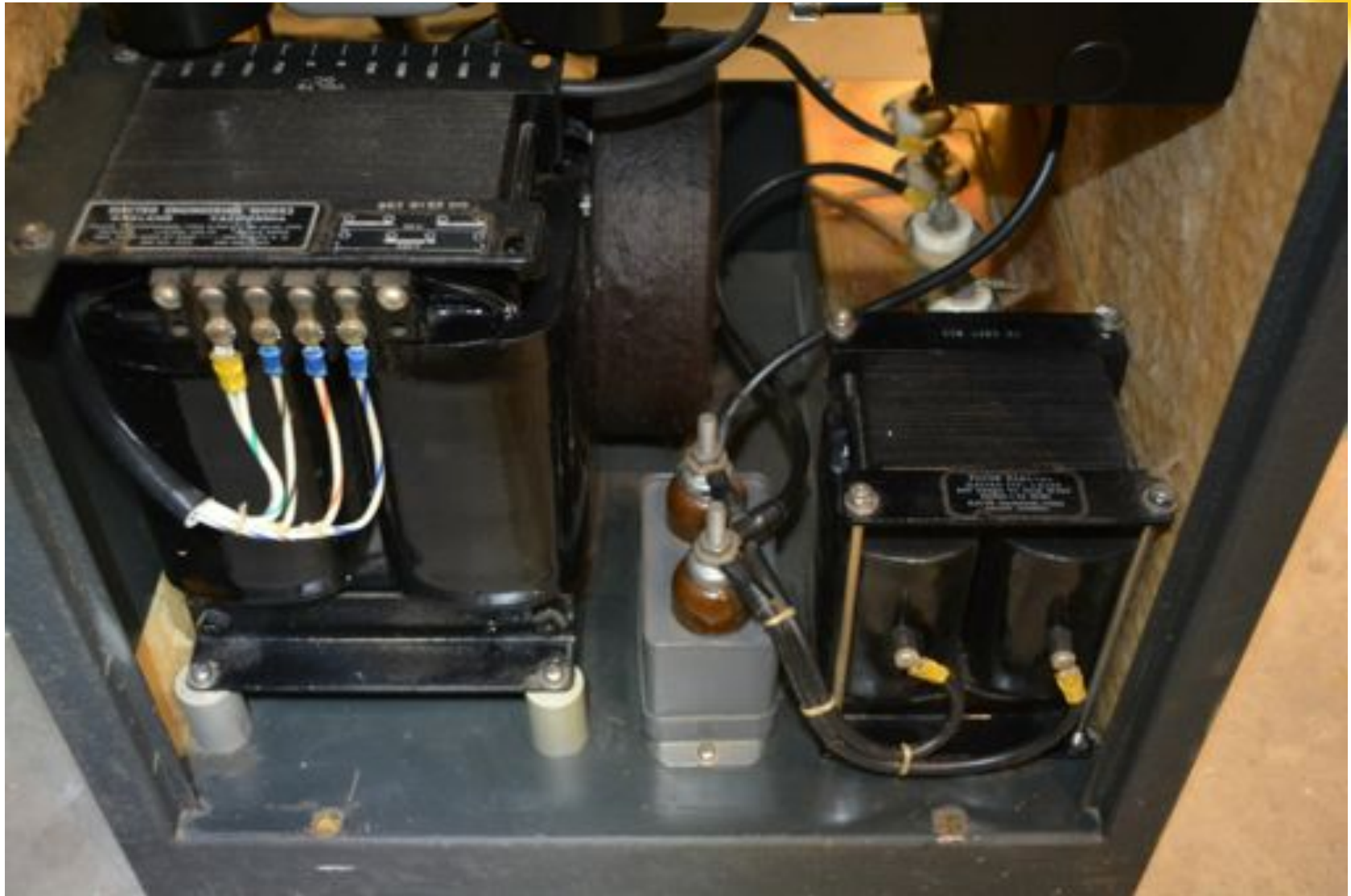

KWS-1 TRANSMITTER

COMPONENT LAYOUT

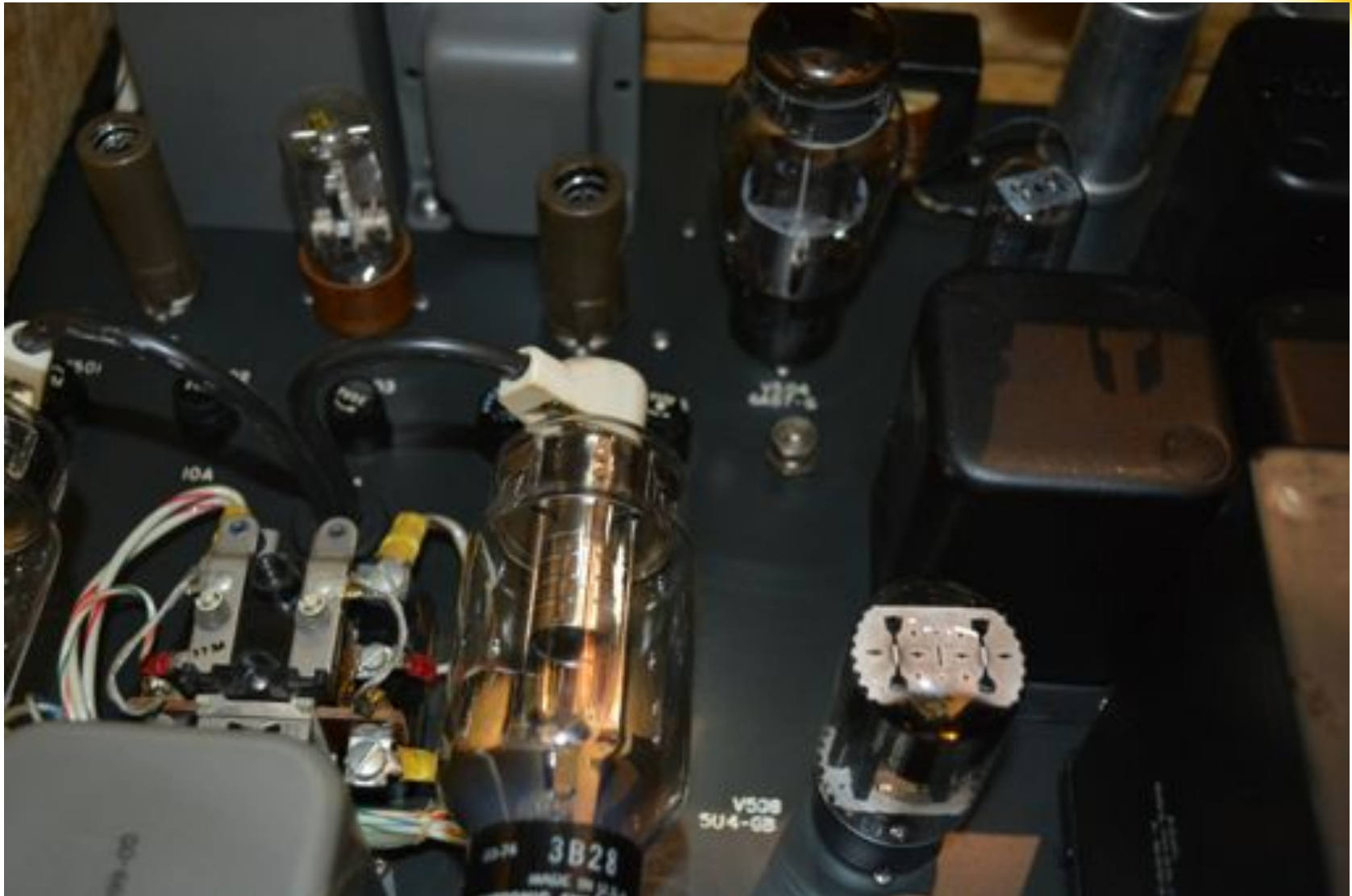

KWS-1 TRANSMITTER

COMPONENT LAYOUT



KWS-1 TRANSMITTER

RF DECK



KWS-1 TRANSMITTER

RF DECK



KWS-1 TRANSMITTER

RF DECK



KWS-1 TRANSMITTER

RF DECK



KWS-1 TRANSMITTER

SERIAL NUMBER PLATE



KWS-1 TRANSMITTER

RF DECK DISASSEMBLY KEEPING TRACK OF THINGS!



KWS-1 TRANSMITTER

RF DECK COUPLING CAP REPLACEMENT



KWS-1 TRANSMITTER

SPRAGUE BLACK BEAUTY (BUMBLE BEE) AND SANGAMO CAPS

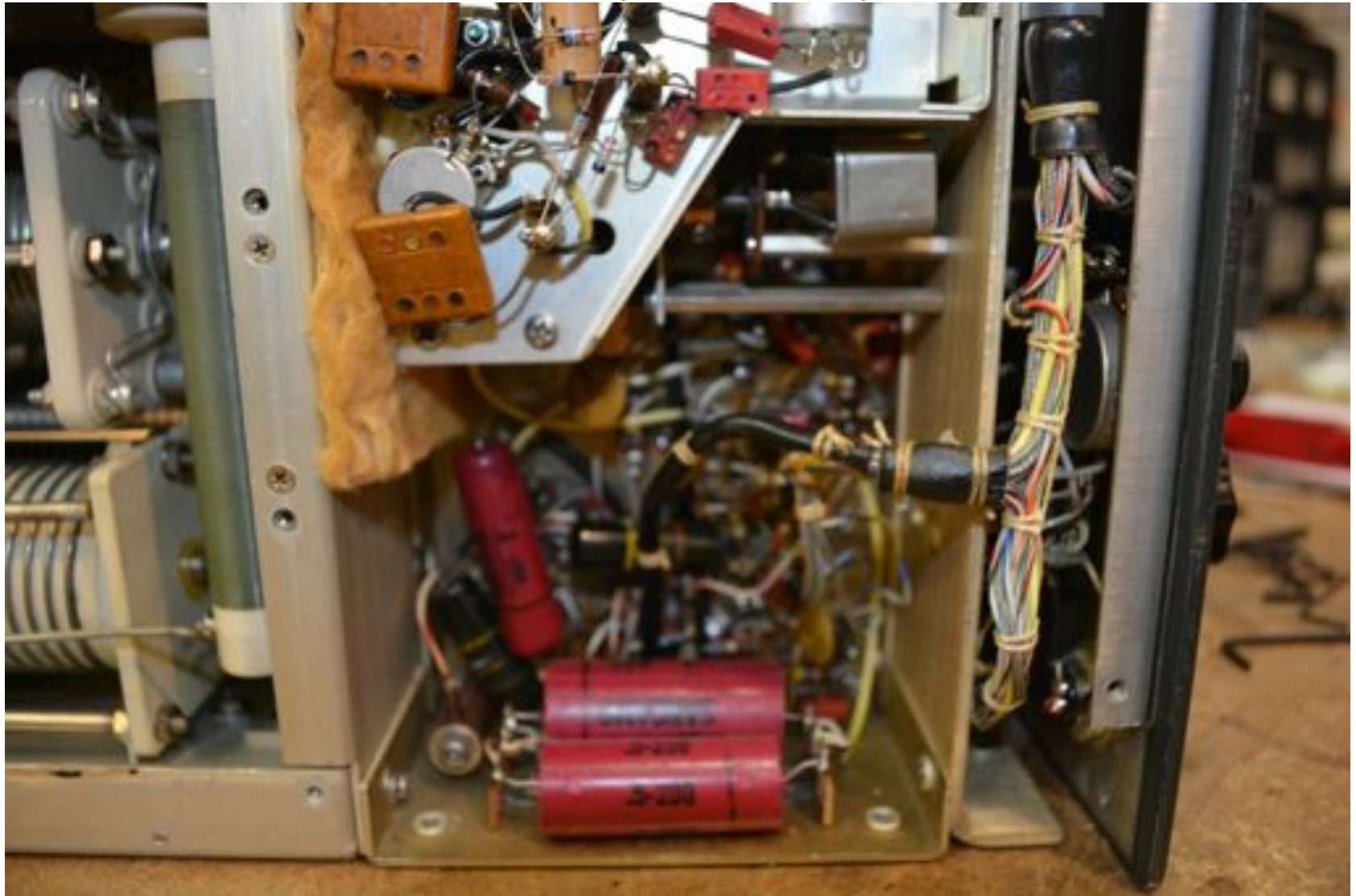

KWS-1 TRANSMITTER

NEW POLYESTER FILM CAPACITORS INSTALLED



KWS-1 TRANSMITTER

CLEAN & INSPECT



KWS-1 TRANSMITTER

DIRTY ROLLER AND BROKEN BERYLLIUM COPPER SPRING



KWS-1 TRANSMITTER



KWS-1 TRANSMITTER

INDUCTOR ROLLER SPRING REPAIR JIG



KWS-1 TRANSMITTER MY FAVORITE METAL POLISH



KWS-1 TRANSMITTER

POLISHED WHEEL AND REPAIRED SPRING



KWS-1 TRANSMITTER

VARIABLE CAPACITOR AND INDUCTOR LUBRICATION



KWS-1 TRANSMITTER

LUBRICATION TOOL



KWS-1 TRANSMITTER

PAPER TOWEL TO CATCH ANY OIL



KWS-1 TRANSMITTER

HOW TO REPAINT THE SHEET METAL?



KWS-1 TRANSMITTER

NAPA BLACK WRINKLE WITH ST JAMES GRAY OVERSPRAY



KWS-1 TRANSMITTER

SEE THE 11 METER POSITION ON THE BAND SWITCH



KWS-1 TRANSMITTER

220 VAC POWER SOURCE



KWS-1 220 VAC POWER SOURCE

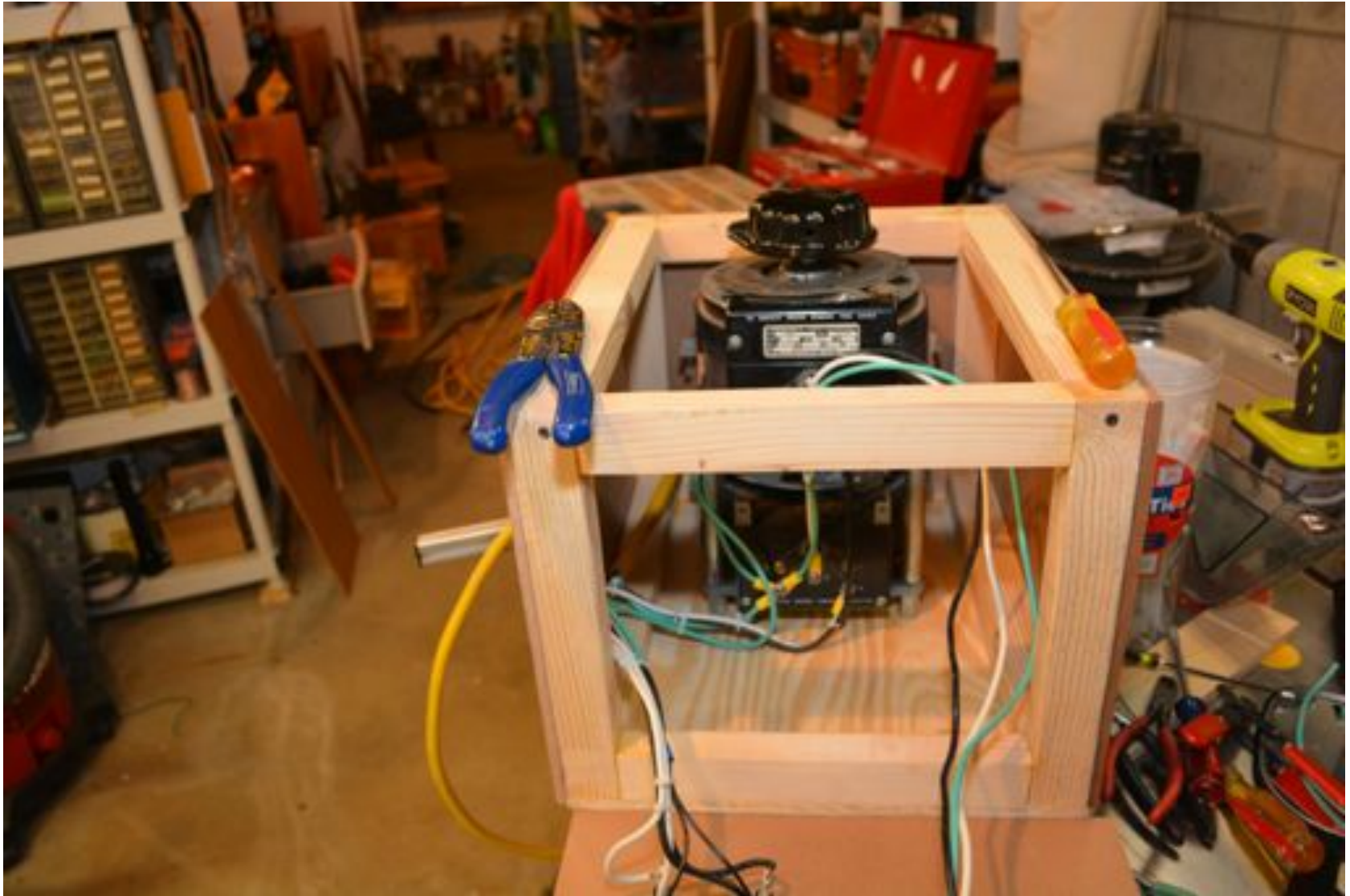

KWS-1 220 VAC POWER SOURCE



KWS-1 TRANSMITTER

FAN BEARING

REPLACEMENT



FAN BEARING

REPLACEMENT



KWS-1 TRANSMITTER

FAN BEARING REPLACEMENT ARTICLE ON THE INTERNET

W8ZR Collins KWS-1 Blower Bearing Replacement [Back to Yonkers Collection](#)

A KWS-1 blower that "rattles" is a common problem and a symptom of worn-out motor bearings. The bearings can be easily replaced, although you'd better plan on committing several hours to the project. Here's all the information you need to replace the bearings in your KWS-1 blower motor.

The basic procedure is first to remove the blower from the KWS-1, which requires removal of the plate transformer (not a big job). The motor is then removed from the blower and disassembled. After the old bearings are removed and replaced, the blower is reassembled and placed back in the KWS-1. This procedure is straightforward, even for someone (like myself) who has never replaced motor bearings before. Now for the details . . .



The Collins KWS-1 is a deluxe high power amateur band transmitter, paired with its matching 75W-4 receiver. These "gold dust twins" represented the "creme de la creme" ham station for well-heeled amateurs in the mid-1950s.



Replacement bearings are standard items available from many sources. I obtained mine from Johnson bearings at 1-800-827-1049. The company's email address is bearings@medford.net

The bearing part number is WC87038 (8x22x-406) felt seal ball bearings. Price is \$5.50 each. You'll need two bearings.



KWS-1 TRANSMITTER

FAN BEARING REPLACEMENT



KWS-1 TRANSMITTER

FAN BEARING REPLACEMENT



KWS-1 TRANSMITTER

FAN BEARING REPLACEMENT



KWS-1 TRANSMITTER

MEASURE EXACT LOCATION FOR RE-ASSEMBLY!



KWS-1 TRANSMITTER

MOTOR DIS-ASSMBLED AFTER A BATTLE!

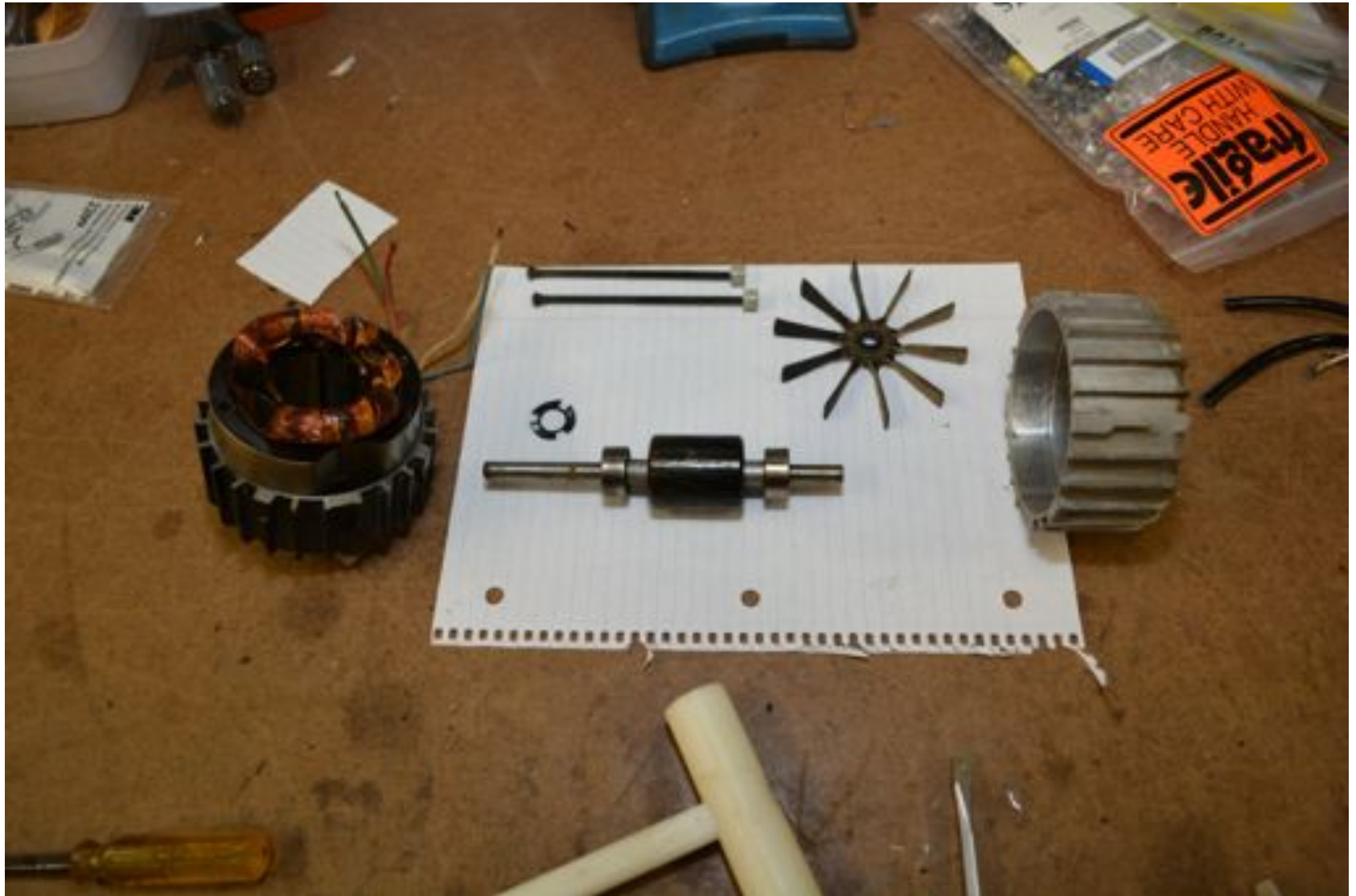

KWS-1 TRANSMITTER

BEARING REMOVAL



KWS-1 TRANSMITTER

NEW BEARING INSTALLATION



KWS-1 TRANSMITTER

FAN TEST RUN



KWS-1 TRANSMITTER

ELECTROLYTIC REPLACEMENT



KWS-1 TRANSMITTER

ELECTROLYTIC REPLACEMENT



KWS-1 TRANSMITTER

ELECTROLYTIC REPLACEMENT



KWS-1 TRANSMITTER



KWS-1 TRANSMITTER



KWS-1 TRANSMITTER

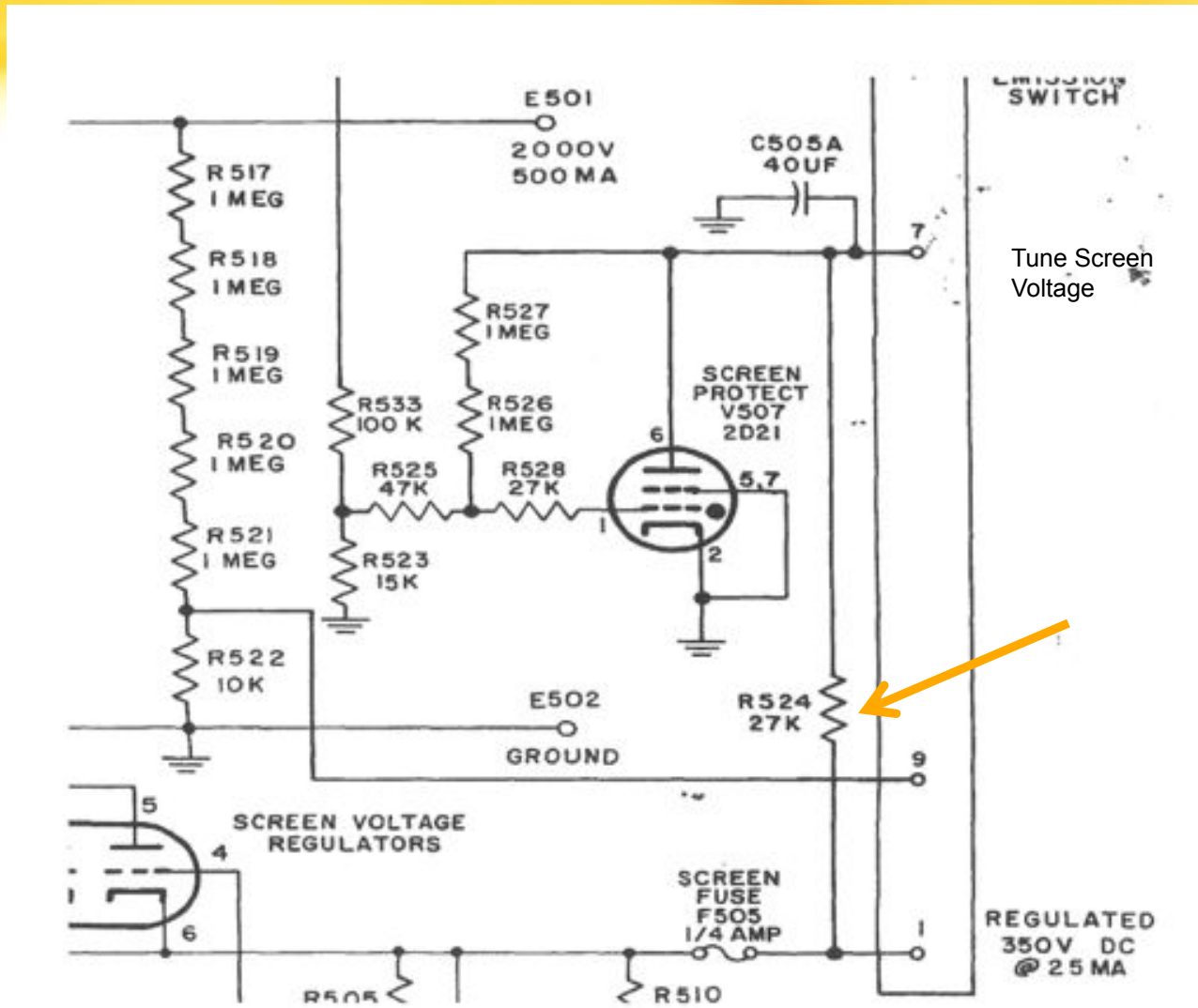

KWS-1 SCREEN SUPPLY

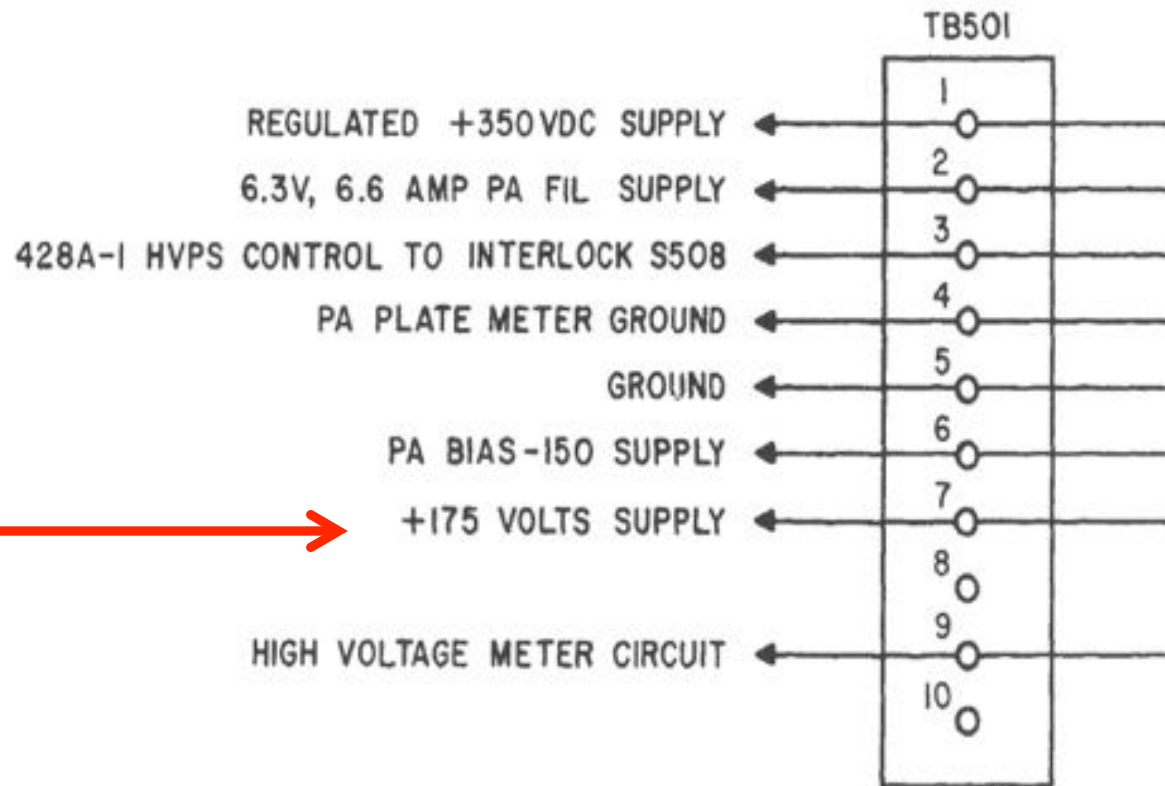

KWS-1 SCREEN SUPPLY

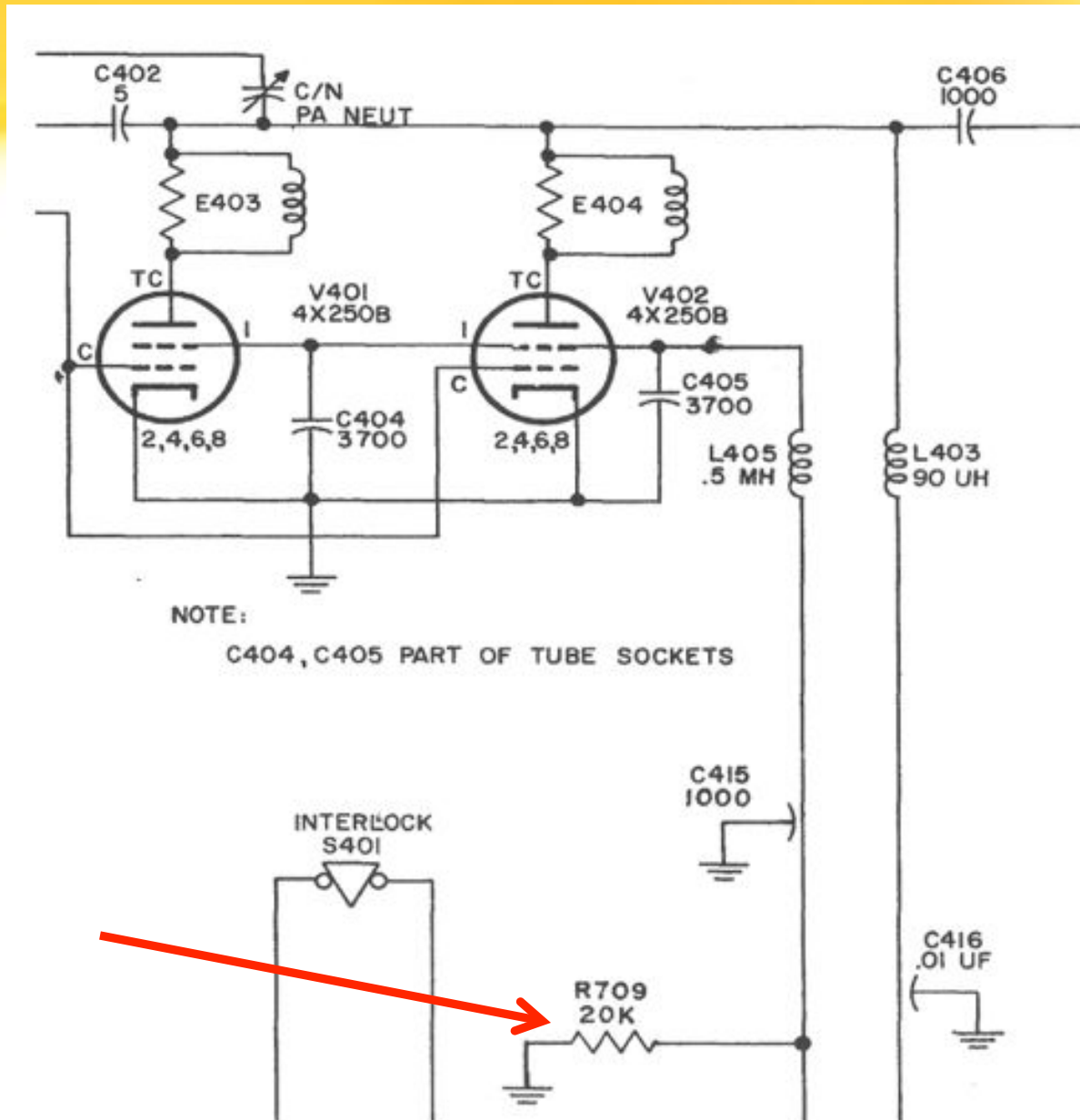

FINAL TEST --NO RF OUTPUT !



DIRTY ANTENNA RELAY CONTACT

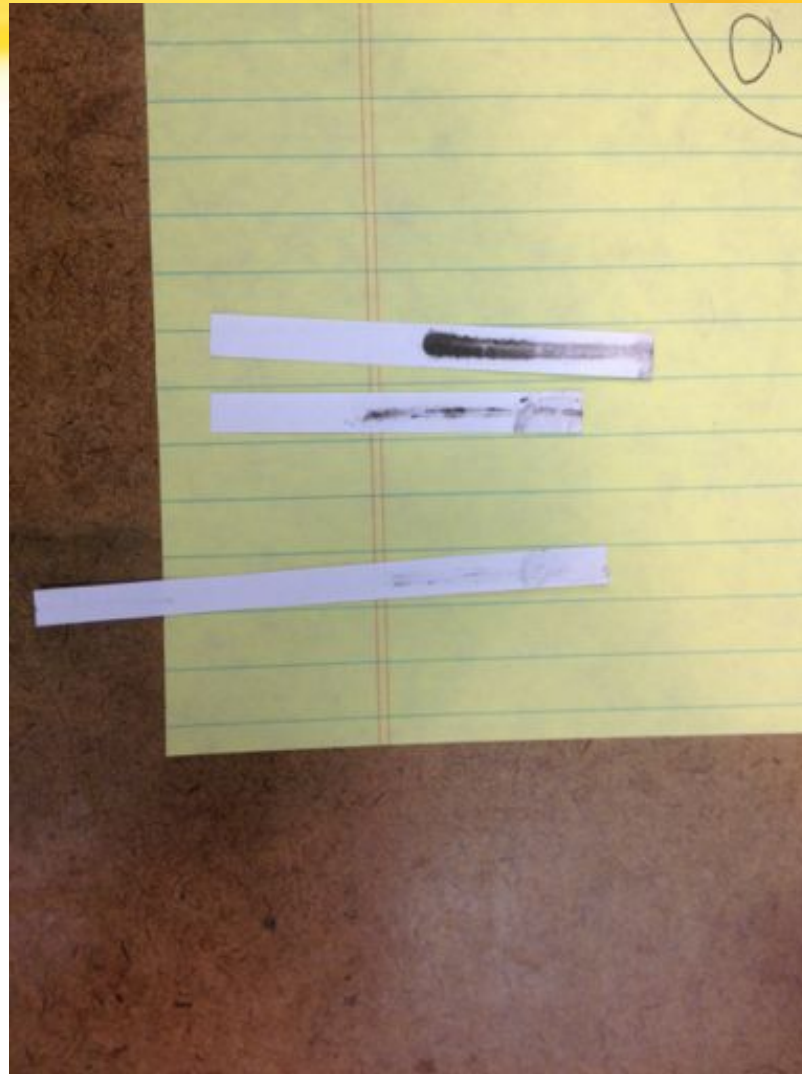

FUNCTIONAL GOLD DUST TWINS



OTHER INTERESTS???



YAESU FT-5000MP

